



SUMMARY

Useful Information

Wall types	4
<hr/>	
Cladding style	4
<hr/>	
Rails & Accessories	5

Install the Cladding

Before you start	7
<hr/>	
Protect the wall	9
<hr/>	
Cut and prepare the rails	9
<hr/>	
Install the rails	10
<hr/>	
Angle with corner profile	12
<hr/>	
Angle without corner profile	13
<hr/>	
Assemble the cladding	14
<hr/>	
Remove a board	14
<hr/>	

CLADDING WITH THE GRAD SYSTEM

Grad® Cladding Basics

01. WALL TYPES

Our cladding system is attached to aluminium rails with clips. However, this rail can be fixed on different types of walls: concrete, cinder-block and wood frame.

Our system makes it possible to compensate for the slopes of walls with a system of wedges.



02. CLADDING STYLE

The cladding can be installed vertically or horizontally. The rails must be installed perpendicular to the boards: for horizontal cladding, the rails are placed vertically.

HORIZONTAL - SILVA

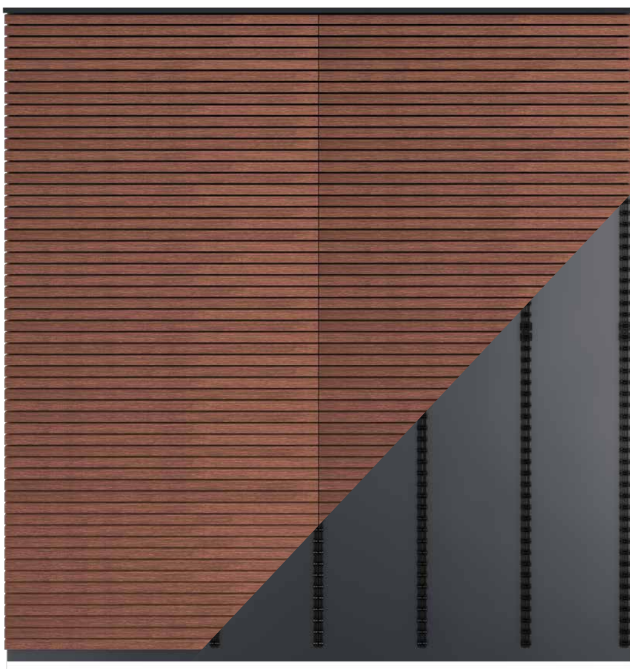

for rails with
56 mm clip spans

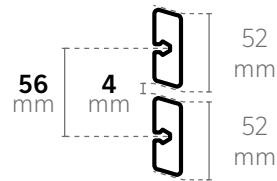

for rails with
69 mm clip spans

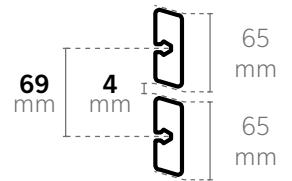

for rails with
71 mm clip spans

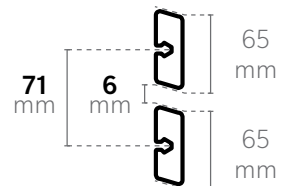
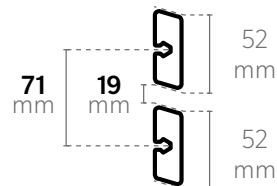

03. RAILS & ACCESSORIES

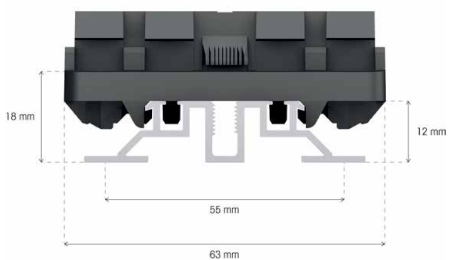
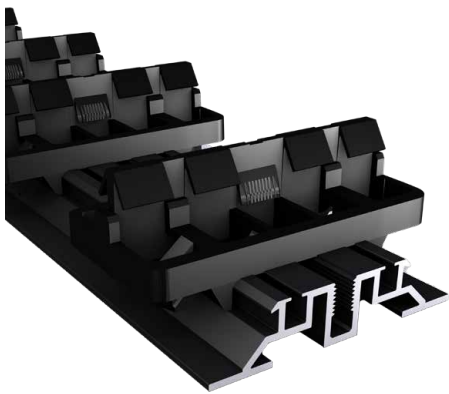

Top Link S & L



Cushion clip



Grad® Clip



Half clip

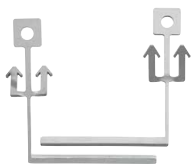

Dismantling keys



Thermo-Pine corner strip

FLAT RAIL

REF	DESCRIPTION	QTY/PALLET	INDICATIVE CONSUMPTION PER M ²
1185	FLAT RAIL - 124 mm clip spacing 32 clips for 16 boards of 120 mm 12 x 55 x 1984 mm.	216 pcs	0,85 pc
1187	FLAT RAIL - 71 mm clip spacing 28 clips for 28 boards 12 x 55 x 1988 mm.	216 pcs	0,85 pc
1188	FLAT RAIL - 56 mm clip spacing 35 clips for 35 boards 12 x 55 x 1960 mm.	216 pcs	0,85 pc
1792	FLAT RAIL - 70 mm clip spacing 28 clips for 28 boards 12 x 55 x 1960 mm.	216 pcs	0,85 pc
1799	FLAT RAIL - 51 mm clip spacing 39 clips for 39 boards 12 x 55 x 1989 mm.	216 pcs	0,85 pc
1822	FLAT RAIL - 69 mm clip spacing 29 clips for 29 boards 12 x 55 x 2001 mm.	216 pcs	0,85 pc
2480	FLAT RAIL - VARIBO 32 clips for 25 boards 12 x 55 x 1968 mm.	216 pcs	0,85 pc
2191	FLAT RAIL - 46 mm clip spacing 43 clips for 43 boards 12 x 55 x 1978 mm.	216 pcs	0,85 pc
2632	FLAT RAIL - 58,5 mm clip spacing 34 clips for 34 boards 12 x 55 x 1989 mm.	216 pcs	0,85 pc

ACCESSORIES

REF	DESCRIPTION	SALES UNIT	QTY/UNIT
2179	Glue - 310 ml cartridge For clips and wooden boards for vertical installation	1 cartridge	n/a
1488	TOP LINK S Joining piece	Bag of 20 pcs	10 bags
1489	TOP LINK L Joining piece	Bag of 20 pcs	10 bags
1486	Grad® Cushion Clip With screws	Bag of 20 pcs	25 bags
1483	Removable Grad® Clip	Bag of 50 pcs	20 bags
1485	Grad® Half Clip	Bag of 50 pcs	20 bags
968	Dismantling Keys - 120 To remove 120 mm boards or smaller	1 pair	6 pairs
1784	Dismantling Keys - 155 To remove 150 mm boards	1 pair	10 pairs
2589	Thermo-Pine Corner Strip 3.8 x 3.8 x 450 cm	1 pc	200 pcs
2611	Touch-Up Paint - Vivid Light Grey for Thermo-Pine Silvered boards - 1L	1 pc	n/a

INSTALL YOUR CLADDING

Understanding the installation steps

BEFORE YOU START

Transportation & Storage

- When transported, Grad® rails should be secured in their original packaging and should be stored indoors before installation.
- Grad® rails can be stored outdoors for short periods of time, just before being used on a project
- Avoid long sun exposure. No heavy object should be stored on top of the rails to avoid possible damage and/or distortion of the rails.

Applications

- The rails can be used for horizontal, vertical, diagonal cladding
- The rails should only be placed onto a flat, even, and hard surface
- Only use Grad® cladding as specified by the manufacturer
- For wooden homes: the rails should be positioned along the studs.

Safety Guidelines

- Wear protective clothing and safety equipment such as safety glasses, gloves, long sleeves, and a mask, particularly when cutting aluminium
- The installer is responsible for identifying and following all building codes and construction safety practices
- Grad® accepts no liability or responsibility for the improper installation of this product
- Grad® for cladding may not be suitable for every application, and it is the sole responsibility of the installer to be sure that Grad® cladding is fit for the intended use. Because all installations are unique, it is also the installer's responsibility to determine specific requirements for each cladding application.

RECOMMENDED EQUIPMENT FOR THE INSTALLATION OF GRAD® CLADDING

- Pneumatic nailer or drill
- Compressors with adequate capacity to supply air for pneumatic tools
- Laser level
- Manual level
- Mitre saw
- Scroll saw
- Finish blade
- Hammer
- Plastic cap for hammer head
- Pliers
- Appropriate personal protection equipment

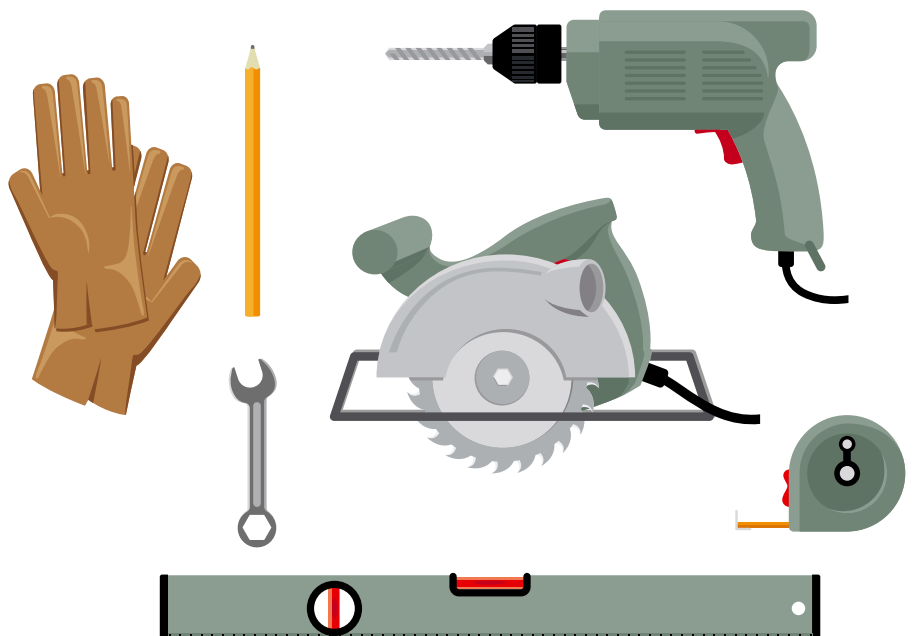

CHECKLIST

- The wall should be straight, levelled, and not damaged
- The rails can be placed either directly on a wall, studs, concrete, or any hard and flat surface, with the appropriate fasteners
- Boards used with Grad system must be compliant to local Building Code
- It is the user's duty to verify they have the right rails to match the boards they want to use and to make sure the rails they intend to use meet all their requirements
- Only material that has been grooved to Grad's specifications can be used with Grad® rails
- Installers must make sure that there are flashing and weather barriers, that they are installed in compliance with local codes, and that the installation meets manufacturer requirements especially in the following proper locations:
 - Openings (doors and windows)
 - Wall/ceiling junction
 - Chimney
 - Transition between another type of cladding surface

DISCLAIMER

Although this guide was designed with as much precision as possible, in accordance with current practices for wood cladding, we are not liable for any errors or omissions that may arise from the use of this guide. All users of this guide fully assume all risks and responsibilities associated with it.

This guide presents the best installation practices for the Grad® cladding system. It supplements the codes and standards and manufacturer installation guides, but is not a replacement or substitute for these. As such, it is the installer's duty and responsibility to take all available documentation into account prior to completing work to ensure the validity of manufacturer warranties.

To ensure simplification, the technical drawings in this guide do not show all construction details to meet requirements of codes and standards.

Finally, do not hesitate to contact us should you have any doubt or should any queries arise regarding specific applications of the Grad rails that would not be covered in this guide.

01. PROTECT THE WALL

Before starting the installation of the cladding, the wall must be protected with a rainscreen (according to the DTU 41.2, when installing an open cladding, the anti-UV rainscreen is mandatory) which is installed directly on the façade.

What type of rainscreen?

With open joint siding :

Resistance to water penetration W1 when new and after weathering (5000 hour UV test - EN 13859-2)

With closed joint cladding :

Resistance to water penetration W2 when new and after weathering (test 336 hours UV - EN 13859-2)

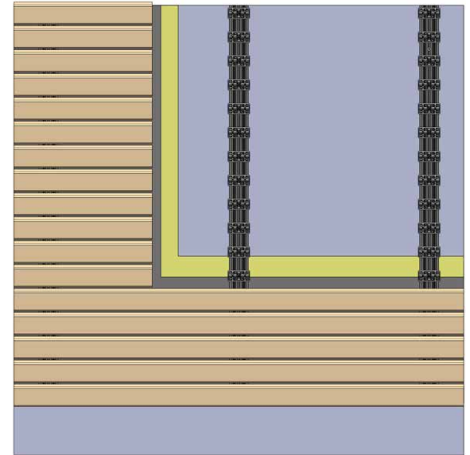

02. CUT + PREPARE THE RAILS

When possible, use full length rails. However, rails may need to be cut if the height of the wall is not 2 meters or a multiple of 2 meters.

Measure the height of the wall, taking into account that the rails **must start at a minimum of 20 cm from the ground.**

Cut the rails to match the height of the wall. When possible, cut between two clips. However, if there is a clip where the cut needs to be, remove the clip using the disassembly keys.

Attn: It is important to protect your eyes with appropriate equipment in case of projections.

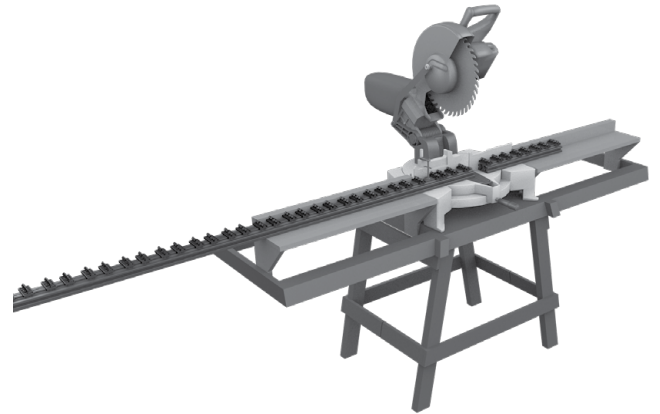

03. INSTALL THE RAILS

With the appropriate hardware, the rails can be installed directly on a wall, studs, concrete, or any hard, flat surface. This can be done with a nail gun using 4/50 mm stainless steel nails, or with a drill using 5/50 mm stainless steel screws. The rails do not need to be pre-drilled if using Stainless Steel self-drilling screws.

All rails are symmetrical and it does not matter which end you start with.

Please refer to the guidelines of the cladding surface material manufacturer to know at what minimum height the cladding should start from the ground.

Install the first rail:

- Starting at either edge of the wall, position the rail at a minimum of 20 cm from the ground and a maximum of 10 cm away from the outside edge of the wall.
- Use a level to ensure the rail is positioned straight on the wall.
- Fix the rail to the wall using the appropriate hardware.
- With a laser level or string, draw a reference line along the length of the wall to ensure that the clips on the other rails are aligned.

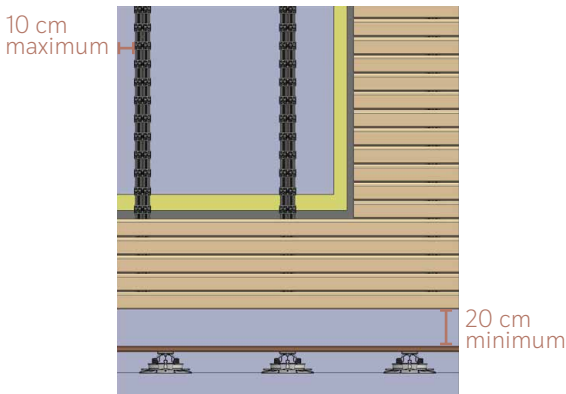

Example of installation on wooden beams

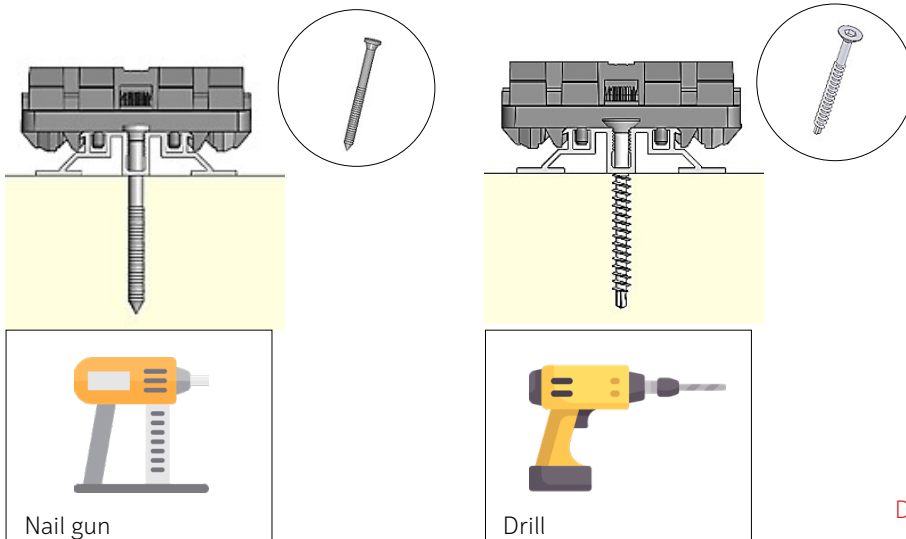

HORIZONTAL INSTALLATION

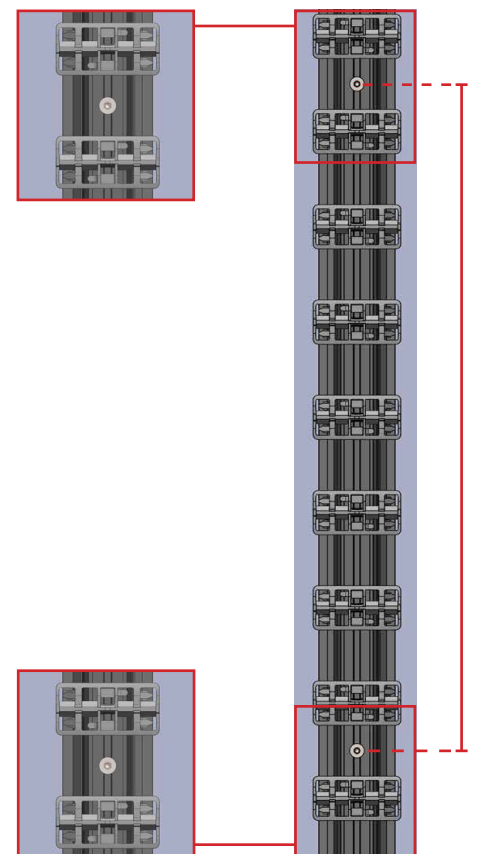
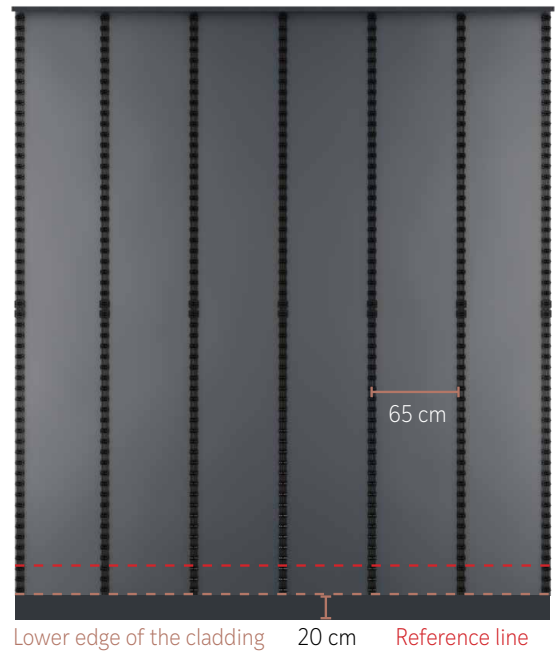

Distance between fasteners: see rail data sheet (variable according to geographical area)

03. INSTALL THE RAILS

Mark the rail spans

The recommended maximum distance between rails is 65 cm.

The distance between nails or screws may need to be adjusted depending on: the height of the building, the wall construction, the terrain, the wind zone.

Install the other rails.

All rails should be parallel to the first rail. The reference line drawn previously should be used to ensure that all of the clips of each rail are properly aligned.

Link two rails together

For facades taller than 2 meters, Top Links quickly align and connect rails with the correct spacing for aluminium expansion.

- Ensure the first rail is secured to the wall.
- Place the second rail against the first one and position the Top Link as shown.
- Use a level to make sure the second rail is straight and secure it to the wall.

Note: please make sure to leave a gap of 6 mm between 2 rails in order to respect the expansion range of the aluminium.

The Top Link does not prevent the boards from unclipping on Silva S profiles.

Rail	Top Link Compatibility
1188	Top link S
1187	Top link L

Angle top rafter

The maximum length allowed between the outermost rail and the edge of a board is 20 cm. When covering an angle top rafter, pieces of the rails must be cut and installed between the main rails to provide additional support. When installing the additional support rails, ensure that the clips are aligned with the clips on the other rails.

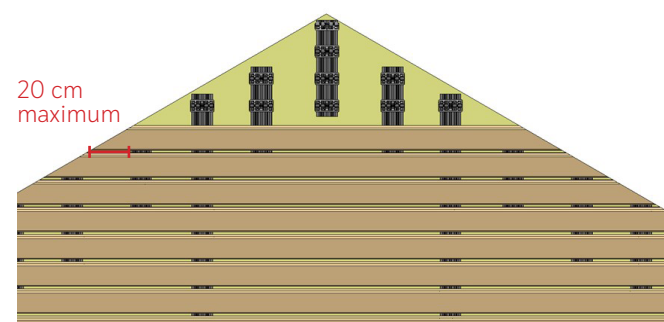
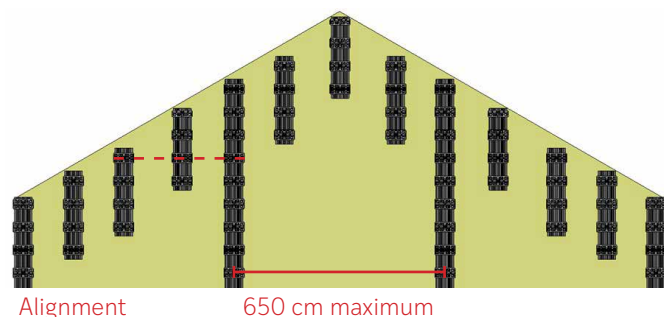
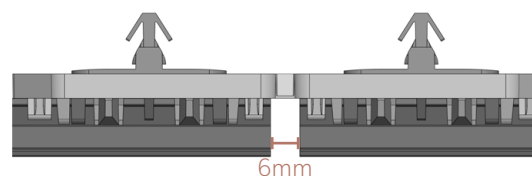
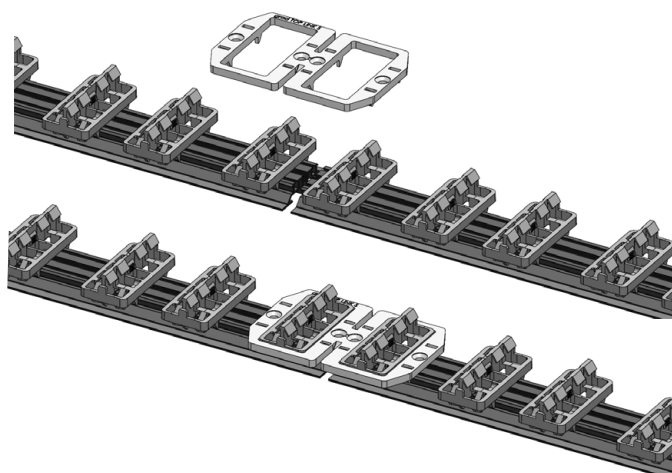
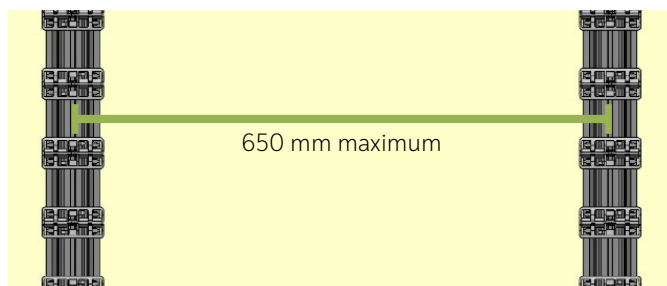

04. FINISH WITH CORNER PROFILE

1. Place the brackets against the wall on both sides
2. Fasten them with the appropriate fasteners for this purpose.
3. Pre-drill the corner profile with a drill and a drill bit adapted to the diameter of the fastener used for the corner profile.
4. The corner profile can be fastened by placing a fastener every 600 mm or less on each side of the profile, leaving enough space between the pre-drilled holes on both sides of the profile.
5. Fix the corner profile in the cleats with the appropriate fasteners

The corner profile can also be adapted to interior corners by following the same assembly principle as above.

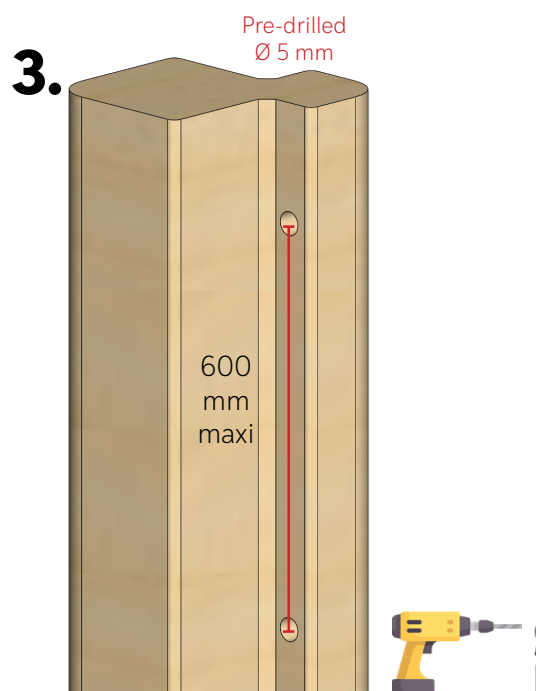
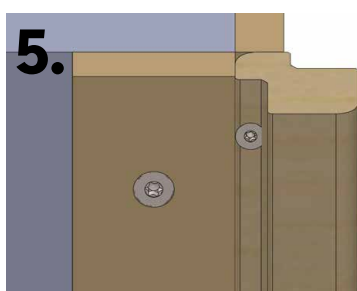
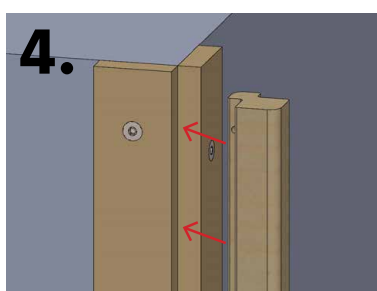
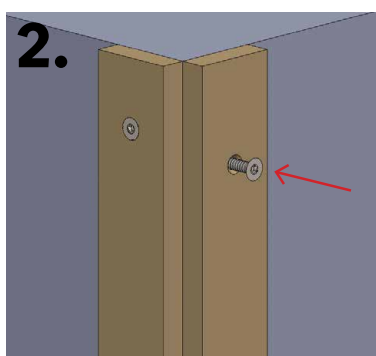
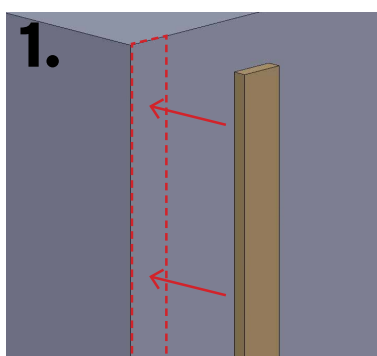
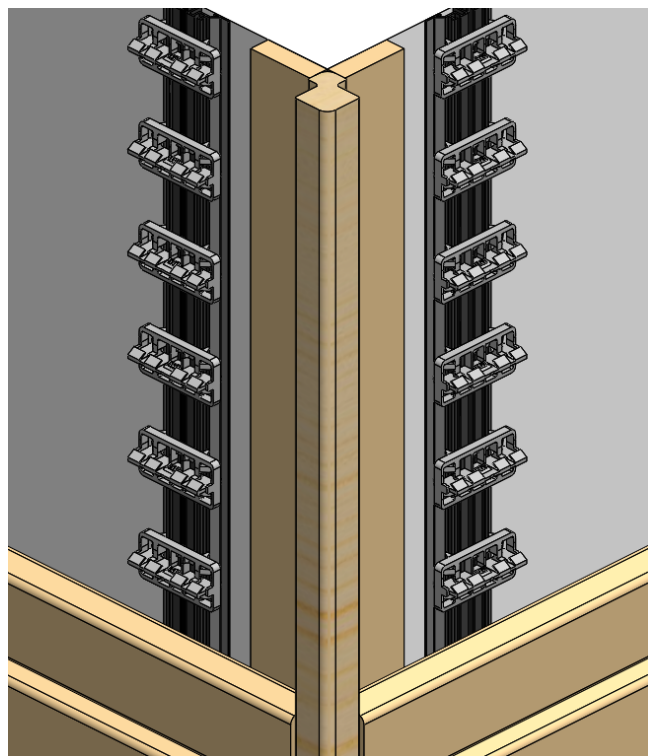

Profile on outside corner

Profile on inside corner

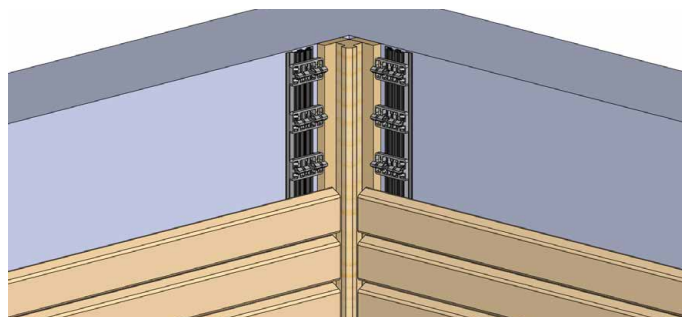
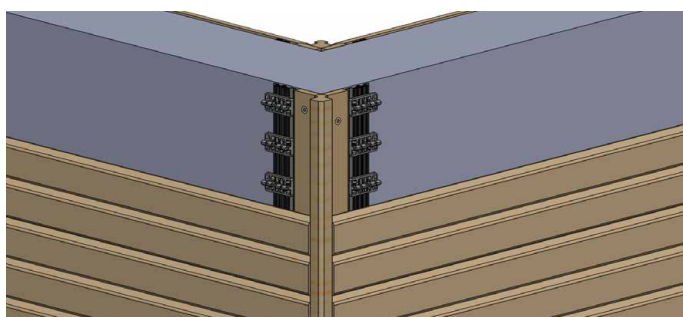

05. FINISH W/O CORNER PROFILE

For finishes without corner profiles, we recommend that the following cuts be made on site:

Mitre-cut finishes for outside corners.

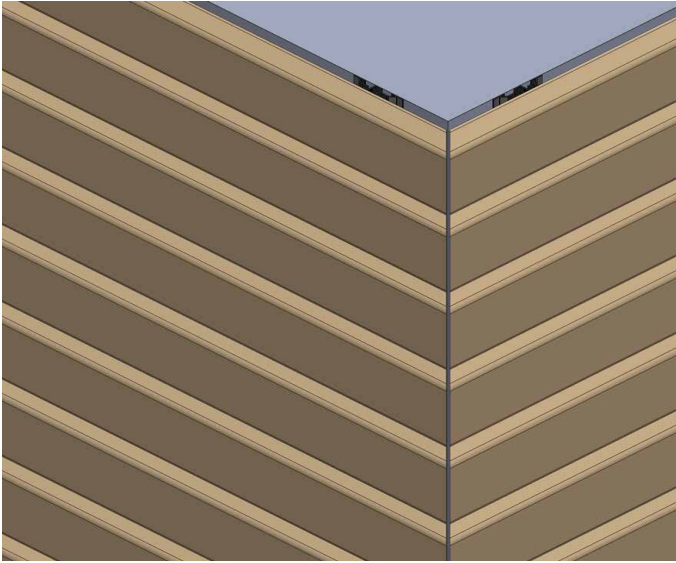

Straight cut finishes for inside corners.

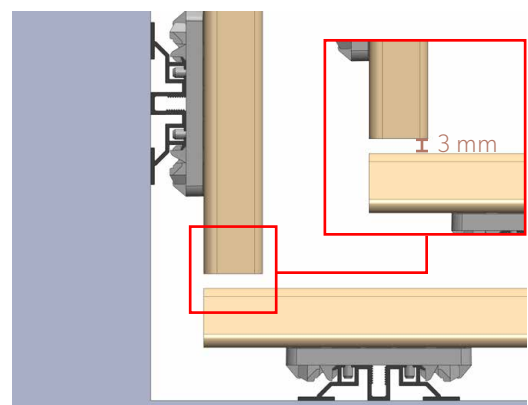
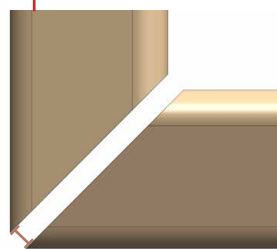
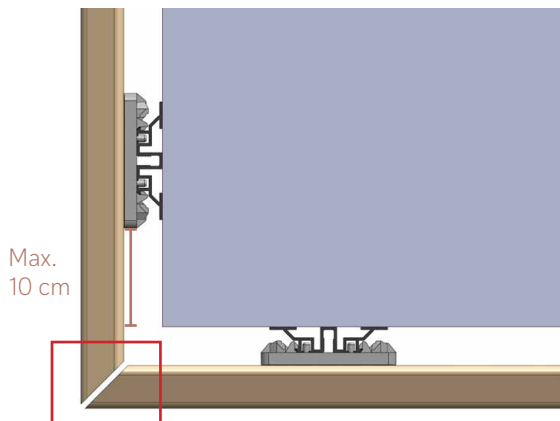
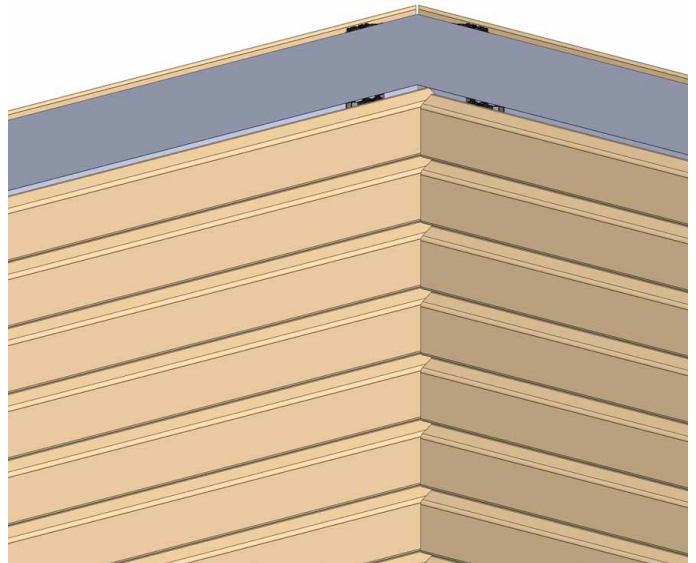

06. ASSEMBLE THE CLADDING

Install the siding by gently pressing the first board by hand onto the first clips at the bottom of the rails. Do not use a hammer or other tools that could damage the board.

Complete the row with additional boards as necessary until you reach the other end of the wall. It is recommended to leave a space between the ends of the boards to avoid water stagnation and to allow the wood to expand. Consult the manufacturer's recommendations for the minimum gap between the ends of the boards (usually 3-5 mm).

Start the second row above the first using the next set of clips, and so on.

Board ends must meet on a rail.

All boards must be clipped to at least two rails to ensure an effective fastening except for the high end of the roof gables.

Please contact Grad® for more information.

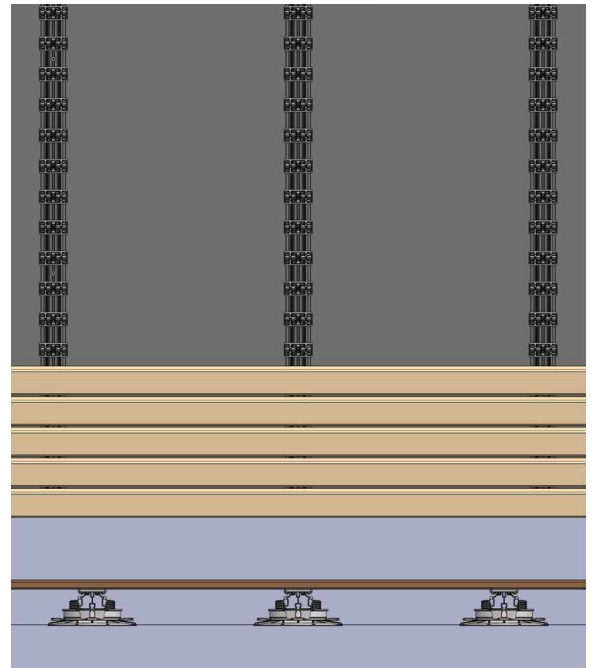

07. REMOVE A BOARD

For cladding, it is possible to remove a board with the dismantling keys. The key number should be chosen according to the siding profile and the spacing between the boards.

The keys must be placed according to the diagram on the right and slid until they are positioned between the clip and the rail. By turning in the opposite direction of the arrows, the boards can be unclipped.

The space between each board must be at least 4 mm to be able to insert the keys.

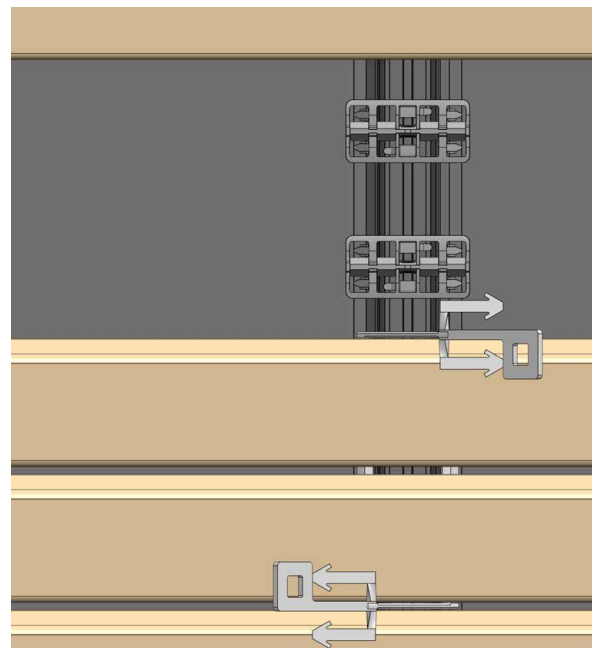
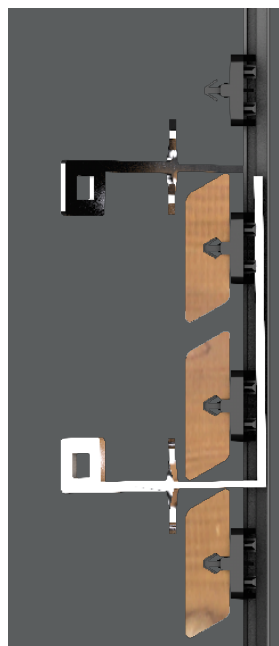

Rails Dismantling Keys Compatibility

1188 Keys 120 ref 968 Rail for 56 mm spacing

1187 Keys 145 ref 1010 Rail for 69/71 mm spacing



Ref: G02EN

© Grad® - 03/2023

Photos, illustrations and documentation are non-contractual.

Please don't litter.

Photo credit front cover: © Coast Studio

Photo credit back cover: © Carpentier